

Typical Applications

The HMC974LC3C is ideal for:

- ATE Applications
- High Speed Instrumentation
- Clock and Data Restoration
- Semiconductor Test Systems
- EW Systems - Threshold Detection

Features

- Propagation delay: 88 ps
- Overdrive & Slew Rate Dispersion: 20 ps
- Minimum Detectable Pulse Width: 60 ps
- Differential Latch Control
- Power Dissipation: 240 mW
- 16 Lead 3x3mm SMT Package: 9mm²

Functional Diagram

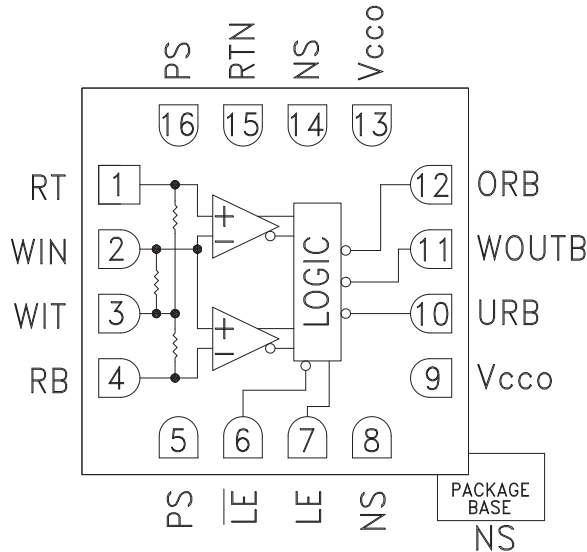

General Description

The HMC974LC3C is a SiGe monolithic, ultra fast window comparator with level latched output driver with reduced swings. The window comparator is based on the HMC674LC3C single comparator and incorporates two such comparators and additional output logic. Three output ports detect whether an analog input signal is above, below or between two reference levels supplied at its input as shown on the timing diagram herein.

The outputs are single-ended negative logic. Incorporating two proven comparators at the input provides good DC and dynamic matching and reduces the input capacitance. The reduced swing output stages are designed to directly drive 400 mV into 50 Ohms terminated to a voltage $V_{TERM} = V_{CCO} - 2V$.

HMC974LC3C features high speed latches that can either be enabled to latch the output data, or can be left in the transparent mode to implement a tracking window comparator.

Electrical Specifications, $T_A = +25^\circ C$

$NS = -3V, PS = +3.3V, V_{CCO} = +2V, V_{TERM} = 0V, V_{CM} = 0V, V_{OD} = 50mV$ [1]

Parameter	Conditions	Min.	Typ.	Max	Units
DC INPUT CHARACTERISTICS					
Offset voltage		-10	±4	10	mV
Bias current	WIT Termination Open	-30	20	30	uA
Differential voltage (max)		-2		2	V
Input impedance WIN to WIT			50		Ohms
Input impedance RT to WIT			50		Ohms
Input impedance RB to WIT			50		Ohms
Common Mode Input Voltage Range		-1.5		1.5	V
Input Capacitance			1		pF



Electrical Specifications, (continued)

Parameter	Conditions	Min.	Typ.	Max	Units
LATCH ENABLE CHARACTERISTICS					
LE / $\overline{\text{LE}}$ "L"			1.6		V
LE / $\overline{\text{LE}}$ "H"			2.4		V
LE / $\overline{\text{LE}}$ Impedance (if not driven the device is unlatched)			7.8		kOhms
DC OUTPUT CHARACTERISTICS					
Output Voltage High Level, VOH (50 Ohms to 0V)			1.06		V
Output Voltage Low Level, VOL (50 Ohms to 0V)			0.73		V
Output Voltage Swing		320	365	410	mV
AC PERFORMANCE					
Propagation Delay Dispersion vs. VOD	For VOD > 50mV		20		ps
Rise Time (each output), tr	20% to 80%		25.3		ps
Fall Time (each output), tf	80% to 20%		21.9		ps
Minimum Detectable Pulse Width	VCM = 0V; ±100 mV Overdrive Voltage		60		ps
Equivalent Input Bandwidth [2]			11		GHz
Input-to-Output Delay			88		ps
Latch-to-Output Delay			83		ps
Max. Input Slew Rate			5		V/ns
Noise (RTI)			6		nV/√(Hz)
Random Jitter (rms)	at 5 Gbps with ±100 mV overdrive		0.2		ps rms
Deterministic Jitter (pp)	at 5 Gbps with ±100 mV overdrive		2		ps
POWER SUPPLIES (including load)					
IPS		13.4	14.9	16.5	mA
INS		28.3	29.9	31.6	mA
Icco		70	72.3	79.6	mA
Pd			240		mW

[1] Vcco can be set between +3.3V and 0V; Vterm = Vcco-2V
RSPECL levels are obtained with Vcco=+3.3V and Vterm=+1.3V;
RSECL levels are obtained with Vcco=0V and Vterm= -2 V

[2] Equivalent Input Bandwidth is calculated with the following formula: $B_{\text{weq}} = 0.22/f$ (TRCOMP2-TRIN2) where TRIN is the 20%/80% transition time of a quasi-Gaussian signal applied to the comparator input, and TRCOMP is the effective transition time digitized by the comparator.



Dispersion vs. Overdrive Voltage

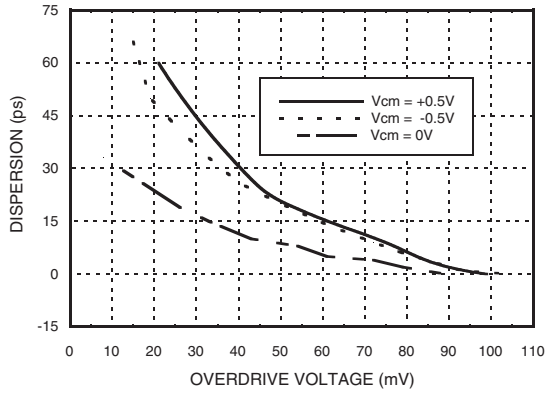

Output Voltage vs. Temperature

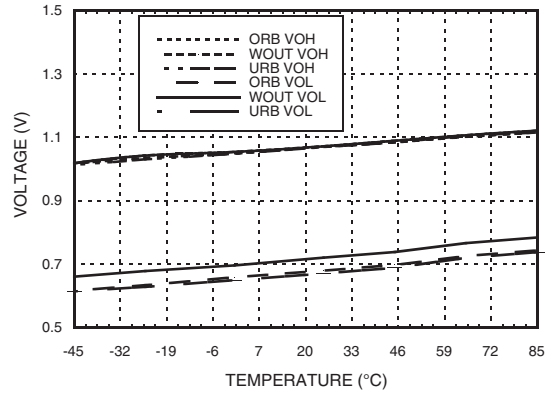

Output Voltage Swing vs. Temperature

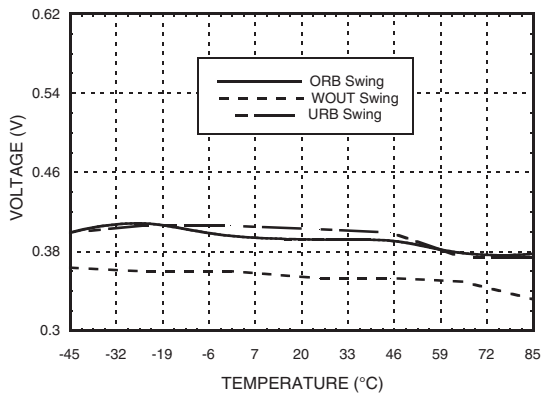

Power Supply Currents

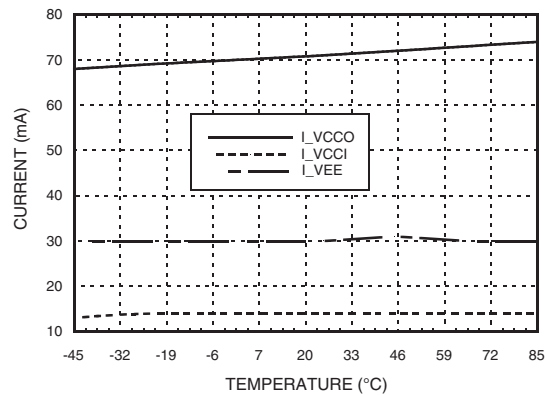

Output Rise / Fall Time

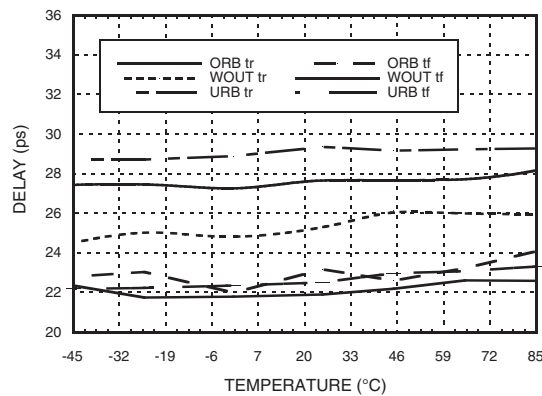

Eye Diagram @ 5 Gbps

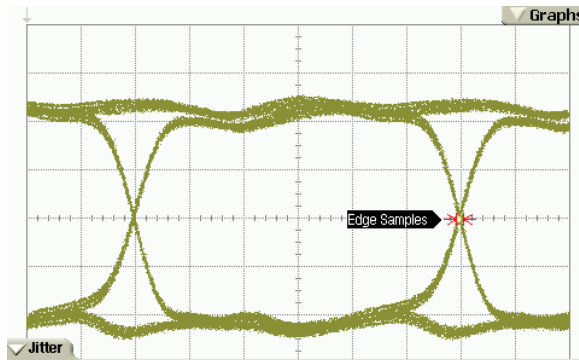

Parameter	Conditions
Bit Rate	5 Gbps
Pattern Length	2 ¹⁵ - 1
DJ (p-p)	2.15 ps
Vertical Scale	80 mV / div
Time Scale	33.3 ps / div

Timing Diagram

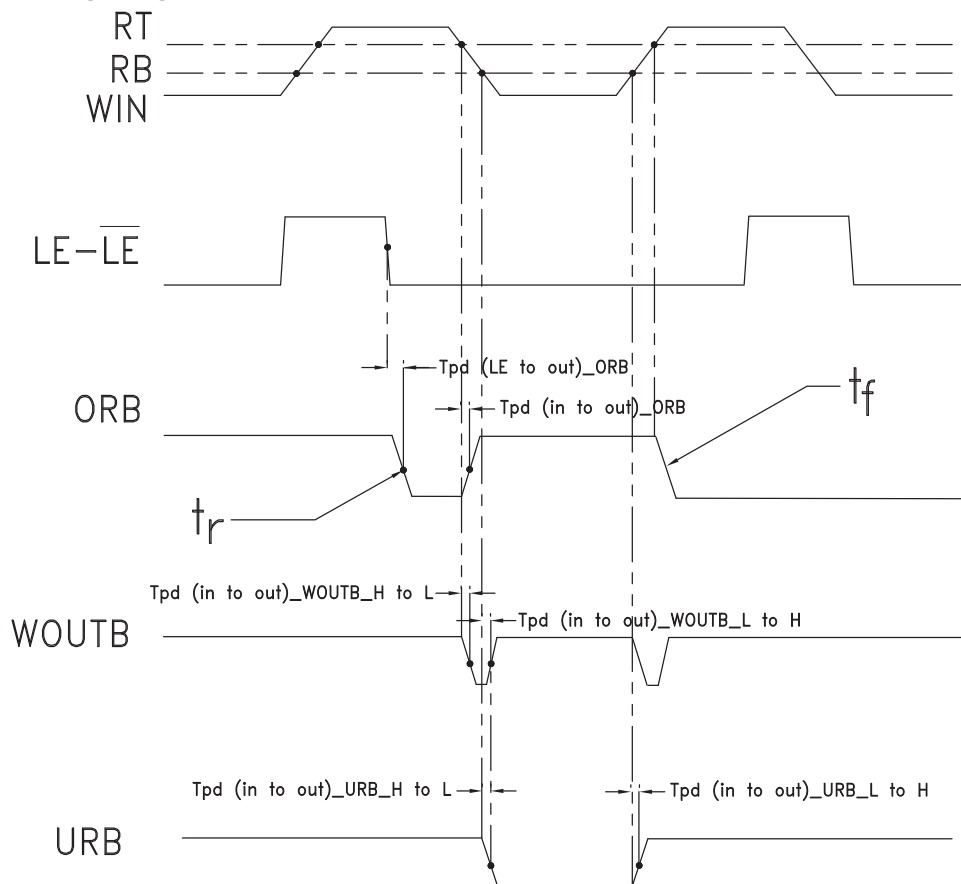

Absolute Maximum Ratings

Input Supply Voltage (V _{cci} to GND)	-0.5V to +4V
Output Supply Voltage (V _{cco} to GND)	-0.5V to +4V
Positive Supply Differential (V _{cci} - V _{cco})	-0.5V to +3V
Input Voltage	-2V to +2V
Differential Input Voltage	-2V to +2V
Output Current	40 mA
Junction Temperature	125°C
Continuous P _{diss} (T = 85°C) (Derate 20.4 mW/°C above 85°C)	0.816 W
Thermal Resistance (R _{th}) (Junction to Lead)	49 °C/W
Storage Temperature	-65°C to +150°C
Operating Temperature	-40°C to +85°C

 ELECTROSTATIC SENSITIVE DEVICE
OBSERVE HANDLING PRECAUTIONS

7

COMPARATORS - SMT

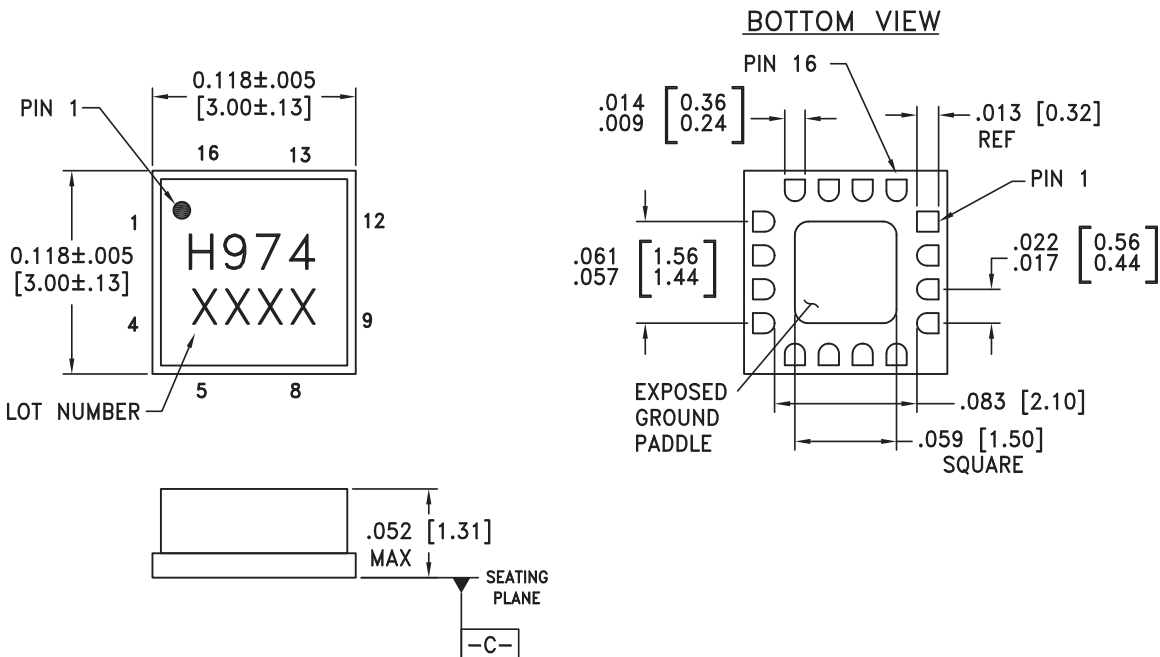
Outline Drawing

NOTES:

1. PACKAGE BODY MATERIAL: ALUMINA
2. LEAD AND GROUND PADDLE PLATING:
30-80 MICROINCHES GOLD OVER 50 MICROINCHES MINIMUM NICKEL.
3. DIMENSIONS ARE IN INCHES [MILLIMETERS].
4. LEAD SPACING TOLERANCE IS NON-CUMULATIVE.
5. PACKAGE WARP SHALL NOT EXCEED 0.05mm DATUM -C-
6. ALL GROUND LEADS MUST BE SOLDERED TO PCB RF GROUND.
7. PADDLE MUST BE SOLDERED TO NS.

For price, delivery, and to place orders, please contact Hittite Microwave Corporation:
20 Alpha Road, Chelmsford, MA 01824 Phone: 978-250-3343 Fax: 978-250-3373
Order On-line at www.hittite.com

Pin Descriptions

Pin Number	Function	Description	Interface Schematic
1	RT	Termination resistor for reference top.	
2	WIN	Window analog input.	
3	WIT	Window CM for termination resistors.	
4	RB	Termination resistor return for reference bottom.	
5, 16	PS	Positive supply voltage input stage.	
6	\overline{LE}	Latch enable input pin, inverting side.	
7	LE	Latch enable input pin, non-inverting side.	
8, 14	NS	Negative power supply, -3V.	
9, 13	Vcco	Positive supply voltage for the output stage.	
10	URB	Under-range output. URB is asserted low when the analog input voltage is below RB.	
11	WOUTB	Window Output. WOUTB is asserted low when the analog input voltage is between RB and RT.	
12	ORB	Over-range output. ORB is asserted low when the analog input voltage range is above RT.	
15	RTN	Return for ESD protection.	
	Package Base	Exposed paddle should be connected to NS (negative power supply, -3V)	

Evaluation PCB

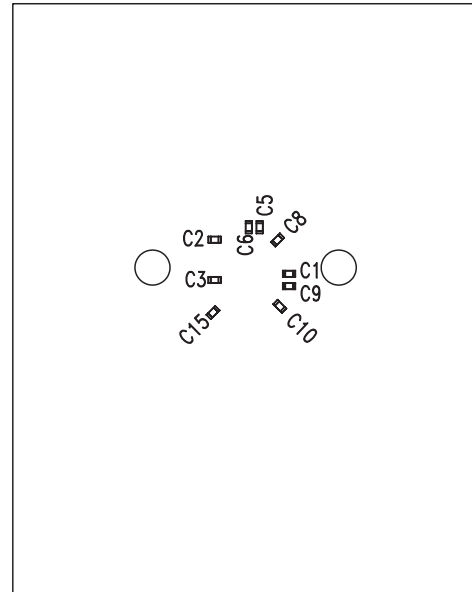
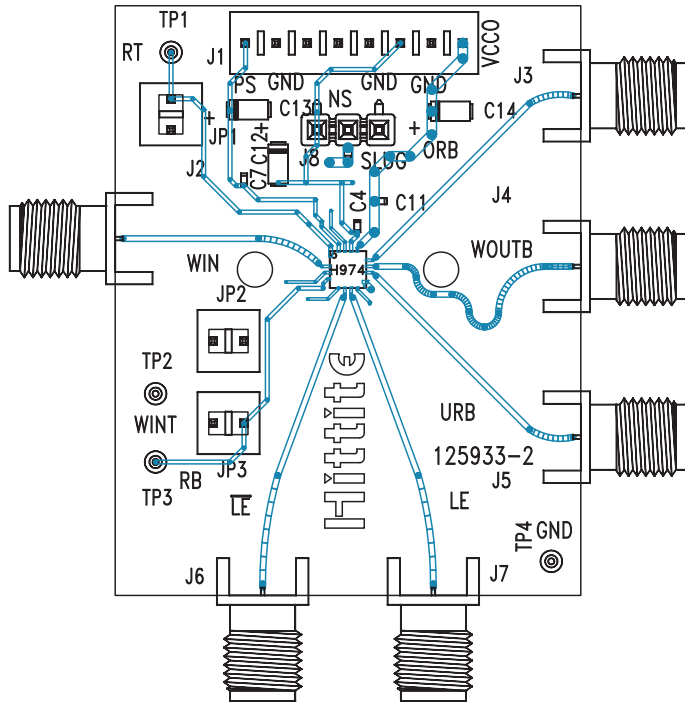

List of Materials for Evaluation PCB 129538 [1]

Item	Description
J1	Conn Header 8 Pos Vert Tin
J2 - J7	K Connector, SRI
J8	Terminal Strip, Single Row 3 Pin
JP1, JP2	Conn Header 2 Pos Vert Tin
C1 - C3, C5, C6, C8 - C10, C15	100 pF Capacitor, 0402 Pkg.
C4, C7, C11	330 pF Capacitor, 0402 Pkg.
C12 - C14	4.7 μF Capacitor, Tantalum
TP1 - TP4	DC Pin
U1	HMC974LC3C Window Comparator
PCB [2]	129533 Evaluation Board

[1] Reference this number when ordering complete evaluation PCB

[2] Circuit Board Material: Arlon 25FR or Rogers 4350

The circuit board used in the application should use RF circuit design techniques. Signal lines should have 50 Ohm impedance while the package ground leads should be connected directly to the ground plane similar to that shown. The exposed metal package base must be connected to NS. A sufficient number of via holes should be used to connect the top and bottom ground planes. The evaluation circuit board shown is available from Hittite upon request.

Application Circuit

